

Web Development

Produced
by

Eamonn de Leastar (edeleastar@wit.ie)

Department of Computing, Maths & Physics
Waterford Institute of Technology

<http://www.wit.ie>

<http://elearning.wit.ie>



Waterford Institute of Technology
INSTITIÚID TEICNEOLAÍOCHTA PHORT LÁIRCE



HTML Evolution

Enterprise Web development

1996

Search White House Press Releases, Radio Addresses, Photos and Web Pages

1. To search White House Press Releases, Radio Addresses, Photos and Web Pages, enter a TERM or PHRASE in the box below which describes your topic of interest (for example, "social security benefits for retired people").

TERM/PHRASE

2. Adjust the START and END dates to limit your search to a specific timeframe. Select from the ITEMS list the number of documents to return from each, then indicate the order in which your results will appear. By "DATE" will return the most recent documents first. By "RELEVANCE" will return the most relevant documents first.

START DATE

01 19 1993

ITEMS RETURNED FROM EACH CATEGORY

10

END DATE

12 27 1996

SORT ORDER

DATE RELEVANCE

Reset this search form

Submit this search form

Start with a new search form



1997

You can search the White House web site for:

- [All White House web features combined](#): Press releases, Radio Addresses, photographs and Web Pages.
 - [White House documents](#): Publicly-released documents since the start of the Clinton Administration.
 - [The contents of this web site](#): Just the pages of this service.
 - [Radio Addresses of the President](#): Search and listen to the President's Saturday Radio Addresses.
 - [Executive Orders](#): Official actions, procedural changes, and organizational changes.
 - [White House photographs](#): Search a public collection of photographs.
- You can also search the GovBot database [all government sites](#)

You can also browse some historic national documents:

- [The Declaration of Independence](#)
- [The Constitution of the United States of America](#)

If you wish to receive White House publications on a daily basis, you can [subscribe to the publications mailing list](#)

Presidential addresses and the White House press releases may be found in the [Briefing Room](#).

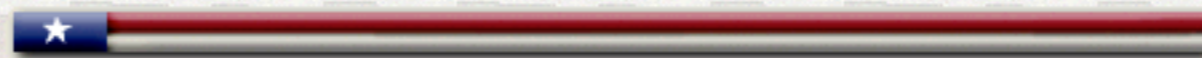

*To comment on this service,
send feedback to the [Web Development Team](#).*

1998

Good Morning



*Welcome to the
White House*

[Tipper Gore Visits Nicaragua and Honduras](#)



[The President & Vice President:](#)

Their accomplishments, their families, and how to send them electronic mail



[Commonly Requested Federal Services](#)

Direct access to Federal Services



[Interactive Citizens' Handbook:](#)

Your guide to information and services from the Federal government



[What's New:](#)

What's happening at the White House -

[President Clinton's Remarks at World AIDS Day Event](#)



[White House History and Tours:](#)

Past Presidents and First Families, Art in the President's House and Tours -- [Tour Information](#)



[Site News:](#)

Recent additions to our site -

[-Become A White House Fellow](#)

[-Current Competitive Vacancies within EOP](#)

[-Vice President's Welfare-to-Work Coalition](#)

[-White House Millennium Council](#)

1999

Good Evening



Welcome to the White House

[President Clinton's Trip to New Zealand](#)

[GOP Tax and Budget Plan Could Force Drastic Cuts in Key Programs](#)

[The Urgent National Need For School Construction and Modernization](#)



[The President & Vice President:](#)

Their accomplishments, their families, and how to send them electronic mail --



[Interactive Citizens' Handbook:](#) Your guide to information about the Federal government



[White House History and Tours:](#) Past Presidents and First Families, Art in the President's House and Tours -- [Tour Information](#)



[The Virtual Library:](#) Search our site, including an extensive archive of White House documents



[White House Help Desk:](#) Frequently asked questions and answers about our service



[Commonly Requested Federal Services:](#)

Direct access to Federal Services



[What's New:](#)

What's happening at the White House-

[-Turkey Earthquake Disaster Information](#)

[-Federal Resources for Drought Information](#)

[-President Clinton's Plan to Strengthen Medicare](#)



[Site News:](#)

Recent additions to our site

[-Office of National AIDS Policy](#)

[-President Clinton's New Markets Tour](#)

[-The President's Trip to Europe](#)

[-White House Millennium Council](#)



[The Briefing Room:](#)

Today's releases, hot topics, and the latest Federal statistics



[White House for Kids:](#)

Helping young people become more active and informed citizens

Welcome To The White House

The Clinton/Gore Administration: Fiscal Discipline Produces the Largest Surplus in History

Tuesday, President Clinton will announce the largest budget surplus and the largest pay-down of debt in American history. [read more](#)

President Clinton and Vice President Gore: Modernizing America's Schools

Tuesday, President Clinton will call on Congress to pass legislation to provide communities new tools to modernize America's schools -- and to do it this year. [read more](#)

President Clinton Helps Make Our Roads Safer for American Families

Monday, President Clinton will sign into law a major safety provision to help set a nationwide impaired driving standard at .08 blood alcohol content (BAC). [read more](#)

President Clinton Calls on Congress to Get the Job Done

Saturday, in his weekly radio address, President Clinton will call on Congress to complete its work and send him a fiscally responsible budget that pays down the debt while investing in America's key priorities -- especially the education of our children. [read more](#)



What's New at the White House

[Millennium Council](#)

Recent Additions

[Radio Address of the President to the Nation - October 21, 2000](#)

2001



THE WHITE HOUSE

President
News
History
For Kids
Tours
Your Government
Appointments

Contact
Text
Help

Search



Special Events



[Opening Day Photos
of Tee Ball at the
White House](#)



America's 43rd President, George W. Bush, and First Lady Laura Bush welcome you to the White House.

In Focus

- [President's Radio Address to the Nation](#)



[President Bush Names Director of the Office of Drug Control Policy](#)

- [Listen to the President's Remarks](#)

- [President Bush Releases Budget](#)



[Interactive Map: See How the Budget Affects Your State](#)

[[Privacy Policy](#) | [Text Only](#) | [Help](#)]

2002

West Wing
connections

Policies in Focus

- National Security
- Homeland Security
- Economic Security
- More Issues
- En Español

News

- Current News
- Video
- Press Briefings
- Proclamations
- Executive Orders
- Radio Addresses

Appointments

- Nominations
- Application

Offices

- Freedom Corps
- Faith-Based & Community
- OMB
- More Offices

Major Speeches

- Iraqi Threat
- U.N. Remarks
- September 11, 2002 Remarks
- Homeland Security Department
- Compassionate Conservatism

Photos



- Photo Essays

Today at the White House, Dec. 2, 2002

Radio Address by the President to the Nation

Good morning. This week all across America we gather with the people we love to give thanks for the blessings in our lives. Each family has its own traditions, yet we are united as a nation in setting aside a day of gratitude. We are grateful for the freedoms we enjoy, grateful for the loved ones who give meaning to our lives, and grateful for the many gifts of this prosperous land. On Thanksgiving we acknowledge that all of these things, and life itself, come not from the hand of man, but from Almighty God. [full story](#) [en Español](#)

◀ [Audio](#)

President's Hanukkah Message

President Bush Friday said, "Americans join in thanking God for our blessings and renew our commitment to the values of faith, family, and community that make us strong. The candles of Hanukkah remind us that in the face of darkness, goodness will prevail." [full story](#)

President Condemns Attacks

President Bush on Thursday said, "I condemn, in the strongest possible terms, the terrorist attacks today at the Likud Party polling place in northern Israel and the Paradise Hotel in Mombasa Kenya, as well as the attempted attack on a civilian airliner shortly after it took off from Mombasa's international airport." [full story](#)

President Gives "Web-Exclusive" Video Tour of the Oval Office



The White House unveiled *Life in the White House*, a new feature on this web site showcasing web-exclusive video tours of the White House led by President Bush, Vice President Cheney, Laura Bush, Lynne Cheney



White House photo by Paul Morse

President George W. Bush talks with some of family members of those who were killed during the September 11 attacks after signing Intelligence Authorization Act in the Roosevelt Room, Wednesday, Nov. 27. The act of Congress will authorize intelligence programs and creating a national commission to investigate the events of September 11, 2001.

Life in the White House [More ▶](#)

Life in the White House

Life in the White House offers the American people a 'birds-eye' view of the people and places making history today and in years past, exclusively on the White House web site.



Iraq Update [More ▶](#)

Saddam Hussein's Iraq

For more than a decade, Saddam Hussein has deceived and defied the will and resolutions of the U.N. Security Council.



3 Video Headlines [More ▶](#)

President Bush Signs Homeland Security Act

President Bush signed the Homeland Security Act establishing the Department of Homeland Security.



2003

In Focus

- Medicare
- Iraq
- National Security
- Economic Security
- Homeland Security
- More Issues
- En Español

News

- Current News
- Video
- Press Briefings
- Proclamations
- Executive Orders
- Radio Addresses

Appointments

- Nominations
- Application

Offices

- Global Communications
- USA Freedom Corps
- Faith-Based & Community
- OMB
- More Offices

Major Speeches

- UN Address
- National Address
- Iraqi Freedom
- National Address
- State of the Union

Photos



▪ Photo Essays

December 5, 2003 | Last Updated 2:04 a.m. (EST)

Remarks by the President at the Pageant of Peace

President Bush on Thursday said, "This evening, we continue a tradition in Washington as we gather to light the National Christmas Tree." [full story](#)

President Bush Signs Identity Theft Legislation



[Play Video](#)

President Bush on Thursday said, "With this legislation, the federal government is protecting our citizens by taking the offensive against identity theft." [full story](#)

- [Fact Sheet](#)
- [Treasury Secretary Discusses Identity Theft](#)

Treasury Secretary John Snow Discusses Identity Theft



Treasury Secretary John Snow on Thursday answered your questions on identity theft and steps the Bush Administration is taking to crack down on this crime. [Click here](#) to read the transcript. [full story](#)

Senior Advisor to Iraqi Ministry of Health Discusses Progress in Iraq



James Haveman, Senior Advisor to Iraqi Ministry of Health, on Thursday discussed progress in the Iraq public health system. [Click here](#) to read the transcript. [full story](#)

President's Statement on Steel

President Bush on Thursday said, "Today, I

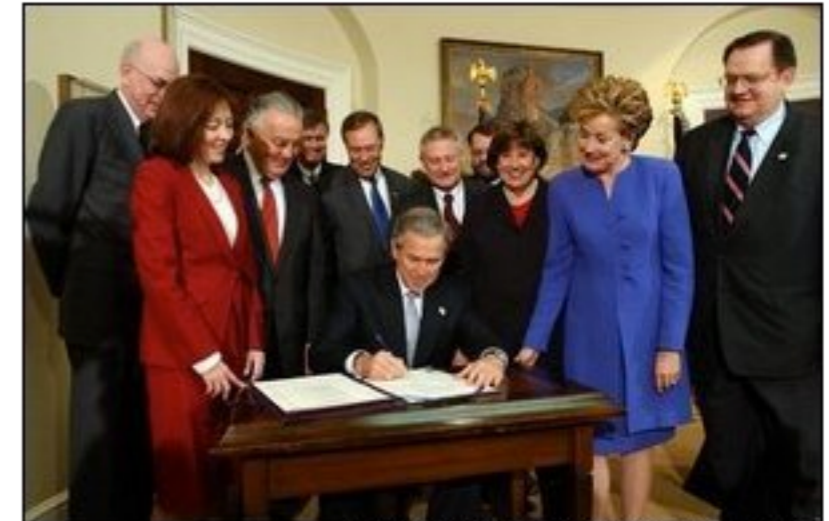

White House photo by Tina Hager

President George W. Bush signs H.R. 2622, the Fair and Accurate Credit Transactions Act of 2003, into law during a ceremony in the Roosevelt Room Thursday, December 4, 2003.

[View webcast](#)

Ask the White House [More](#)

President's Economic Advisor Greg Mankiw to Discuss Economy

Greg Mankiw, Chairman of the Council of Economic Advisers, will discuss the latest economic numbers Friday at 10:45am. [Submit a question.](#)



The Healthy Forests Initiative [More](#)

On December 3, President Bush signed into law the Healthy Forests Restoration Act of 2003 to reduce the threat of destructive wildfires while upholding environmental standards and encouraging early public input during review and planning processes. [More...](#)



IRAQ Progress in Iraq [More](#)

Progress in Public Health Care

All 240 hospitals in the country are open and providing services as well as the 1200 primary health care centers. [More...](#)



THANKSGIVING AT THE WHITE HOUSE [More](#)

2004



The White House

PRESIDENT GEORGE W. BUSH

HOME

President * News * Vice President * History & Tours * First Lady * Mrs. Cheney

YOUR GOVERNMENT KIDS ESPAÑOL CONTACT PRIVACY POLICY SITE MAP SEARCH



EMAIL UPDATES

SEARCH

Issues

- Economy
- Iraq
- Education
- National Security
- Homeland Security
- More Issues
- En Español
- Hurricane Relief

News

- Current News
- Press Briefings
- Proclamations
- Executive Orders
- Radio

Talk Back

- Ask the White House
- White House Interactive

Appointments

- Nominations
- Application

Offices

- Global Comm
- Freedom Corps
- Faith-Based & Community
- OMB
- More Offices

Major Speeches

- Remarks with PM Blair
- Honoring Veterans
- Press Conference
- Acceptance Speech

- Photo Essays
- Search photos by date

November 20, 2004 | Last Updated 3:31 a.m. (EST)

President Bush Nominates Margaret Spellings as Secretary of Education



Play Video ▶

President Bush on Wednesday said, "In Margaret Spellings, America's children, teachers and parents will have a principled, determined ally in my Cabinet. She has my complete trust and she will be an outstanding Secretary of Education." [full story](#)

President Bush Names Harriet Miers as Top Counsel

President George W. Bush on Wednesday announced his intention to appoint Harriet Miers to be Counsel to the President. Ms. Miers will fill the position held by Judge Alberto Gonzales, following his confirmation by the Senate. [full story](#)

President's Remarks at the Clinton Presidential Center Dedication

President Bush on Thursday said, "Laura and I are really pleased to be a part of this happy and historic occasion. On this day of dedication, we honor the man from Hope, Arkansas, who became the 42nd President of the United States." [full story](#)

President Pardons "Biscuits and Gravy" in Annual Turkey Ceremony



Play Video ▶

President Bush on Wednesday said, "The National Thanksgiving Turkey will soon be on stage for all to see, but he's not going to end up on the table. I'm granting him a Presidential

Pardon." [full story](#)

In Focus: Thanksgiving 2004



More Photos

White House photo by Eric Draper

As pictured on an outdoor video screen, President George W. Bush addresses attendees during the dedication of former President Bill Clinton's Presidential Center and Park in Little Rock, Ark., Nov. 18, 2004. "He was a tireless champion of peace in the Middle East. He used American power in the Balkans to confront aggression and halt ethnic cleansing. And in all his actions and decisions, the American people sensed a deep empathy for the poor and the powerless," said President Bush.

Ask the White House

More ▶

White House Turkey Guy on Ask

The White House Turkey guy (Christopher Smith) answered your questions on the annual pardoning of the Thanksgiving Turkey on Wednesday. [Read the Full Transcript.](#)



THANKSGIVING AT THE WHITE HOUSE

More ▶

Gobble the Vote

The public has spoken and the names for this year's Thanksgiving Turkey and runner up have been selected. Your vote made a difference. [Click here](#) to watch the ceremony and to learn more about the annual ceremony.



WHITE HOUSE INTERACTIVE

More ▶

Email the White House...

Q: David from Massachusetts:
CONGRATULATIONS MR. PRESIDENT!!!!!!
YAHOO!!!!!!

2005



EMAIL UPDATES

SEARCH

Issues

- Hurricane Relief
- Homeland Security
- Judicial Nominations
- National Security
- Renewal in Iraq
- Jobs & Economy
- Social Security
- [More Issues »](#)

News

- Current News
- Press Briefings
- Proclamations
- Executive Orders
- Radio

RSS Feeds

Major Speeches

- Hurricane Relief
- War on Terror
- Energy Act
- Second Term Agenda

Interact

- Ask the White House
- White House Interactive

Your

Government

- President's Cabinet
- USA Freedom Corps
- Faith-Based & Community
- OMB
- NSC
- [More Offices »](#)

Appointments

- Nominations
- Application



December 21, 2005 | Last Updated 1:42 a.m. (EST)

President Attends Swearing-In of Millennium Challenge CEO



[Play Video ▶](#)

President Bush on Tuesday said, "Almost two years ago, we launched the Millennium Challenge Account as an entirely new way to provide aid. The MCA is based on clear principle: countries that seek our aid must demonstrate a record of performance. ... John Danilovich is the right person to take on this part of our efforts to fight poverty." [full story](#)

Press Briefing by Scott McClellan



[Play Video ▶](#)

Watch Tuesday's Press Briefing with White House Press Secretary Scott McClellan. [full story](#)

Service During the Holidays Discussed



Desiree Sayle, Deputy Assistant to the President and Director of USA Freedom Corps, discussed how Americans can engage in volunteer service and care for a neighbor in need this holiday season

Tuesday. [Read the full transcript.](#)

Press Conference of the President



[Play Video ▶](#)

President Bush on Monday said, "This new threat required us to think and act differently. And as the 9/11 Commission pointed out, to prevent this from happening again, we need to connect the dots before the enemy attacks, not after. And we need to recognize that dealing with al Qaeda is not simply a matter of law enforcement; it requires defending the country



[More Photos](#)

White House photo by David Bohrer

Vice President Dick Cheney discusses earthquake relief efforts with Pakistani President Pervez Musharraf, Tuesday Dec. 20, 2005. President Musharraf thanked the Vice President for the US relief assistance and said, "I don't think we could have managed the relief operation without your support." White House photo by David Bohrer



Strategy for Victory in Iraq

On Sunday, during a LIVE Address to the Nation from the Oval Office, President Bush discussed the strategy to help the Iraqi people defeat the terrorists and build an inclusive democratic state. [Click here to learn more.](#)



ASK THE WHITE HOUSE

[More ▶](#)

Saddam Hussein Trial

Christopher Reid, Regime Crimes Liaison, U.S. Embassy in Iraq, will discuss Saddam Hussein's trial for crimes against humanity Wednesday at 1 PM ET. [Submit a question.](#)



Renewing the Patriot Act

The Patriot Act is vital tool that law enforcement and intelligence officials have used to protect the American people. The President calls on the Senate to renew the provisions within the Patriot Act that are set



2006

Issues

- [Budget Management](#)
- [Education](#)
- [Energy](#)
- [Health Care](#)
- [Homeland Security](#)
- [Hurricanes](#)
- [Immigration](#)
- [Jobs & Economy](#)
- [Judicial Nominations](#)
- [Medicare](#)
- [Middle East](#)
- [National Security](#)
- [Pandemic Flu](#)
- [Patriot Act](#)
- [Renewal in Iraq](#)
- [Social Security](#)
- [More Issues](#)

News

- [Current News](#)
- [Press Briefings](#)
- [Proclamations](#)
- [Executive Orders](#)
- [Radio](#)

 [RSS Feeds](#)

Major Speeches

- [Press Conference](#)
- [Secure Fence Act](#)
- [Military Commissions](#)
- [Safe Port Act](#)
- [School Safety](#)

Interact

- [Ask the White House](#)
- [White House](#)
- [Interactive](#)

Your Government

December 5, 2006 | Last Updated 2:17 p.m. (EST)

Press Briefing by Tony Snow

Today's Press Briefing with White House Press Secretary Tony Snow has concluded. Video from the Press Briefing will be available on the web

site shortly.

President Bush Meets with Secretary of Defense Nominee Robert Gates

President Bush on Tuesday said, "Bob Gates will be a fine Secretary of Defense. I appreciate the fact that he's getting a hearing today in the United States Senate. I hope for a speedy confirmation so he can get sworn in and get to work. ... Those who wear the uniform know they'll have a friend in Bob Gates in the Defense Department. He admires our military; he respects those who have volunteered to serve our country." [full story](#)

President Bush Meets with United Nations Ambassador John Bolton

President Bush on Monday said, "I received the resignation of Ambassador John Bolton. I accepted. I'm not happy about it. I think he deserved to be confirmed. We're going to miss you in this administration. You've been a stalwart defender of freedom and peace. You've been strong in your advocacy for human rights and human dignity. You've done everything that can be expected for an Ambassador." [full story](#)

President Bush Meets with His Eminence Abdul-Aziz Al-Hakim, Leader of the Supreme Council for the Islamic Revolution in Iraq

President Bush on Monday said, "I told His

President George W. Bush and Mrs. Laura Bush sit with children of deployed U.S. military personnel and watch a performance of "Willy Wonka" by members of The Kennedy Center Education Department in the East Room Monday, Dec. 4, 2006. White House photo by Eric Draper

View webcast ►

Holidays at the White House

The White House is celebrating "Deck the Halls and Welcome All" throughout the holiday season. [Click here](#) to view photos and learn more about holiday decorations and events.

Strong U.S. Economy

Economic growth continues with 92,000 new jobs created in October. There have been over 6.8 million new jobs created since August of 2003, and the unemployment rate decreased to 4.4 percent, the lowest rate since May 2001. [Learn more about the President's pro-growth policies.](#)



2007

Search

December 26, 2007

The White House

IN FOCUS

- [Budget Management](#)
- [Defense](#)
- [Economy](#)
- [Education](#)
- [Energy](#)
- [Environment](#)
- [Global Diplomacy](#)
- [Gulf Coast](#)
- [Health Care](#)
- [Homeland Security](#)
- [Immigration](#)
- [Iraq](#)
- [Judicial Nominations](#)
- [Medicare](#)
- [Middle East](#)
- [National Security](#)
- [Pandemic Flu](#)
- [Patriot Act](#)
- [Veterans](#)

[more issues](#) →

News

- [Current News](#)
- [Press Briefings](#)
- [Proclamations](#)
- [Executive Orders](#)
- [Radio](#)

[more news](#) →

Interact

LATEST NEWS

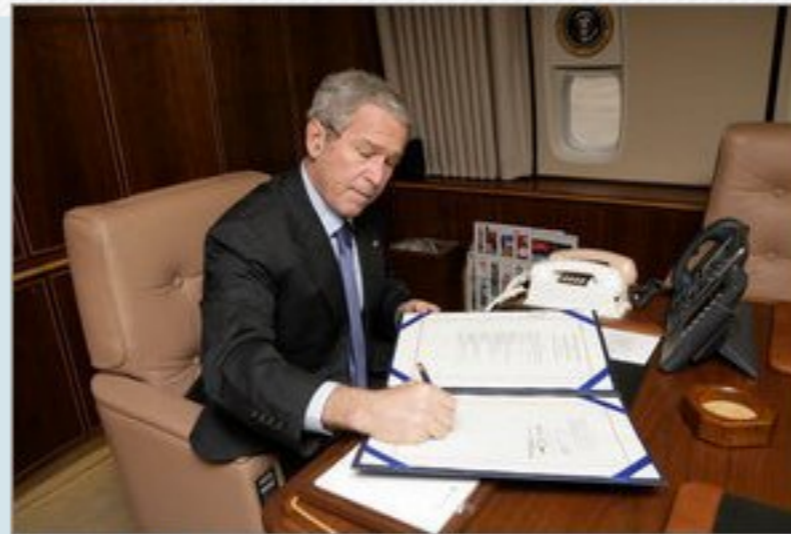

[+ more photos](#) White House Photo by Chris Greenberg

President George W. Bush signs into law H.R. 2764, the Consolidated Appropriations Act 2008, also known as the omnibus, making appropriations for the Department of State, foreign operations, and related programs for the fiscal year ending September 30, 2008, and for other purposes, after boarding Air Force One Wednesday, Dec. 26, 2007. White House photo by Chris Greenberg

President Bush Signs H.R. 2764 into Law

Today, I signed into law H.R. 2764, legislation that will fund the Federal Government within the reasonable and responsible spending levels I proposed – without raising taxes and without the most objectionable policy changes considered by the Congress. This law provides a down payment for the resources our troops need, without arbitrary timelines for withdrawal. The Congress should quickly take action next year to provide the remainder of the funding needed by our troops.

President's Radio Address

FEATURES

Barney Cam VI: Holiday in the National Parks



CHOOSE A FORMAT



[Holiday in the National Parks](#) →

Honoring Our Veterans

Through the generations, America's men and women in uniform have defeated tyrants, liberated continents, and set a standard of courage and idealism for the entire world. Our Nation pays tribute to those who have proudly served in our Armed Forces.



[In Focus: Veterans](#) →

Helping Homeowners

On December 20, 2007, President Bush signed the Mortgage Forgiveness Debt Relief Act of 2007, which helps homeowners in need of assistance avoid foreclosure. This will help



2008

July 30, 2008 Last updated 11:41 p.m. (EDT)

 **IN FOCUS**

- [Afghanistan](#)
- [Africa](#)
- [Budget Management](#)
- [Defense](#)
- [Economy](#)
- [Education](#)
- [Energy](#)
- [Environment](#)
- [Global Diplomacy](#)
- [Gulf Coast](#)
- [Health Care](#)
- [Homeland Security](#)
- [Immigration](#)
- [International Trade](#)
- [Iraq](#)
- [Judicial Nominations](#)
- [Middle East](#)
- [National Security](#)
- [Veterans](#)

[more issues](#) →

News

- [Current News](#)
- [Press Briefings](#)
- [Proclamations](#)
- [Executive Orders](#)
- [Radio](#)

[more news](#) →

Interact

- [Ask the White House](#)
- [White House Interactive](#)

Your Government

- [President's Cabinet](#)
- [USA Freedom Corps](#)

Latest News

 **LATEST NEWS**





[+ more photos](#) White House Photo by Joyce N. Boghosian

President George W. Bush, joined by Vice President Dick Cheney and members of the Cabinet, addresses his remarks Wednesday, July 30, 2008 in the Rose Garden at the White House, urging Congress to lift the ban on offshore exploration on the Outer Continental Shelf. White House photo by Joyce N. Boghosian

 **President Bush Signs H.R. 5501, the Tom Lantos and Henry J. Hyde United States Global Leadership Against HIV/AIDS, Tuberculosis and Malaria Reauthorization Act of 2008**

 President Bush on Wednesday said, "With this legislation, America is showing its tremendous regard for the dignity and worth of every human being. This afternoon, I want to speak directly to those around the world who have, or think they may have, HIV: A positive diagnosis does not have to be a reason for shame. So don't let shame keep you from getting tested or treated. Your life is treasured by the people who love you. It is precious in the eyes of God. It matters to the people of the United States."

-  [In Focus: HIV/AIDS](#)
-  [In Focus: Health Care](#)
-  [Fact Sheet: A Historic and Lifesaving Commitment to Fight HIV/AIDS](#)

 **President Bush Meets with Cabinet Members**

 **Press Briefing by Dana Perino**

Features

 **FEATURES**

 **Ask the White House**

Discuss Energy

Join Keith Hennessey, Assistant to the President for Economic Policy and Director of the National Economic Council, on Friday, August 1 at 1:00 PM to discuss the President's Energy policy.



[Submit a Question](#) →

 **Freedom Agenda**

The United States is committed to the advance of freedom and democracy as the great alternatives to repression and radicalism. The most powerful weapon in the struggle against extremism is the universal appeal of freedom. Freedom is the best way to unleash the creativity and economic potential of a nation, the only ordering of a society that leads to justice, and the only way to achieve and permanently protect human rights.



[In Focus: Freedom Agenda](#) →

 **Energy Security for the 21st Century**

America's prosperity depends on reliable, affordable and **secure sources of energy**. President Bush believes the power of technology and the innovative spirit of America will reduce our reliance on foreign sources of energy, which will help ensure a growing and prosperous America in the 21st Century.



[In Focus: Energy Security](#) →

 **Tax Relief**

President Bush's 2001 and 2003 tax relief fueled economic growth and reduced the marginal rate for every income tax bracket. By the end of last year, Americans would have paid an additional \$1.3 trillion in taxes had it not been for the President's tax relief. If the President's tax relief is allowed to expire at the end of 2010, Americans will pay about \$280 billion more in taxes each year. With the largest tax increase in history looming, Congress should make the President's tax relief permanent.



[In Focus: Tax Relief](#) →

 **International Trade**

America is economically stronger when we participate fully in the worldwide economy. When 95% of the potential customers for American products live outside the U.S., America must reject policies that would result in economic



Your WEEKLY ADDRESS

The President restates his commitment to small business as key to economic recovery—from the Recovery Act to Financial Stability to Health Reform—and pledges more to come.

1 2 3 4



White House Photo, Lawrence Jackson, 10/24/09

A NEW FOUNDATION



The President's Plan for Health Insurance Reform

Cut through the rhetoric on health insurance reform. Read the essentials of the President's plan, and watch a video with highlights of his speech to Congress.

[BACK](#) | [NEXT](#)

SEARCH *the* SITE

PHOTO *of the* DAY



President Barack Obama prepares to speak to servicemen and women at Naval Air Station Jacksonville, in Jacksonville, Fla. Official White House Photo by Pete Souza, October 26, 2009

THE BLOG

October 27, 2009 at 3:07 PM EDT

[The Smart Grid: Creating Jobs, Saving Energy and Cutting Electric Bills](#)

October 27, 2009 at 2:46 PM EDT

[Only A Few Days Left](#)

EPA Administrator Lisa Jackson has a special

FEATURED LEGISLATION

[Veterans Health Care Budget Reform and Transparency Act](#)

Signed: Thursday, October 22, 2009

[Cash For Clunkers Extension](#)

Signed: Thursday, August 6, 2009

2010

the WHITE HOUSE PRESIDENT BARACK OBAMA



Get Email Updates

Contact Us



BLOG

PHOTOS & VIDEO

BRIEFING ROOM

ISSUES

the ADMINISTRATION

the WHITE HOUSE

our GOVERNMENT

MIDDLE CLASS TAX CUTS *Held Hostage*

The President duly applauds the two Senate Republicans who broke the blockade on small business help. But he denounces attempts by Republicans to hold middle class tax cuts hostage for an additional tax cut for the wealthiest 2 percent of Americans.

Watch the Video

1

2

3

4



President Obama and his economic team, White House Photo, Pete Souza, 9/15/10

FEATURED TOPICS



A Boost for Small Business

The President applauds Congress for finally breaking the partisan Republican blockade on help for small business that would strengthen our recovery.

Learn More

← BACK | NEXT →

SEARCH the SITE

Search WhiteHouse.gov

Search

HealthCare.gov

Take health care into your own hands



2011

TWITTER TOWN HALL

In the first ever Twitter Town Hall at the White House, President Obama answers your questions on jobs and the economy submitted through Twitter. Ask your questions now, watch the event live, and learn more for your chance to join the live audience.

[Learn More](#)



FEATURED TOPICS



Travels with the First Lady

First Lady Michelle Obama travels to South Africa and Botswana during an official visit focused on youth leadership, education, health and wellness.

[Watch the Video](#)

[← BACK](#) | [NEXT ▶](#)

SEARCH *the* SITE

YOUR FEDERAL TAXPAYER RECEIPT



[Launch the Receipt](#)

THE BLOG

July 5, 2011 at 7:06 PM EDT

President Obama Addresses the Status of the Deficit Negotiations

President Obama delivers remarks to discuss the status of efforts to find a balanced approach to deficit reduction.

 [Includes Video](#)

WHITE HOUSE SCHEDULE

[The President's Schedule](#)
[The Vice President's Schedule](#)

FEATURED LEGISLATION

[FDA Food Safety Modernization Act](#)

Signed: Tuesday, January 4, 2011

PHOTO *of the* DAY



HAPPY INDEPENDENCE DAY

The White House marks July 4, 2012 with a concert on the South Lawn for military heroes and their families. Learn more about past Independence Day celebrations.

[View the Gallery](#)

[Learn More](#)



Fireworks begin as the Killers perform on the South Lawn of the White House, White House Photo, Pete Souza, 7/4/10

FEATURED TOPICS

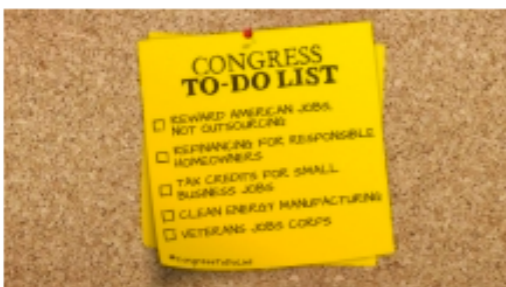

The To Do List for Congress

Before Congress leaves for summer recess, President Obama is calling on them to take action to create jobs and help the middle class.

[← BACK](#) | [NEXT ▶](#)

SEARCH the SITE

WE the PEOPLE YOUR VOICE IN OUR GOVERNMENT

Create and Sign Petitions on WhiteHouse.gov

[GET STARTED NOW ▶](#)

THE BLOG

July 3, 2012 at 3:03 PM EDT

President Obama Remembers Andy Griffith

President Obama says that Griffith, "warmed the hearts of Americans everywhere."

July 3, 2012 at 1:36 PM EDT

America the Beautiful

Visit the White House for more information

WHITE HOUSE SCHEDULE

[The President's Schedule](#)
[The Vice President's Schedule](#)

FEATURED LEGISLATION

[H.R. 6064, the Temporary Surface Transportation Extension Act of 2012](#)

Signed: Friday, June 29, 2012

PHOTO of the DAY

2012



BLOG

PHOTOS & VIDEO

BRIEFING ROOM

ISSUES

the ADMINISTRATION

the WHITE HOUSE

our GOVERNMENT

Taking a climate

President Obama discusses carbon pollution and the impacts of climate change.

SEE THE PLAN

White House On the Go
Download our mobile apps



Take A Virtual Tour
View the Residence, East Wing and West Wing



Inside the White House

- Interactive Tour
- West Wing Tour
- Video Series
- Décor and Art
- Holidays

Presidents

First Ladies

The Oval Office

The Vice President's Residence & Office

Eisenhower Executive Office Building

Camp David

Air Force One

White House Fellows

- President's Commission
- About the Fellowship
- 2013 National Finalists
- Current Class
- Staff Bios

White House Internships

- About Program
- Presidential Department Descriptions
- Selection Process
- Internship Timeline & FAQs

Tours & Events

- 2013 Easter Egg Roll
- Kitchen Garden Tours
- Take a Virtual Tour of the White House

Mobile Apps

POPULAR TOPICS



Immigration

Together we can build a fair, effective and common sense immigration system.



Health Care

Get the facts on health care reform, and find out how to get insurance.



Education

Preparing students for the jobs of the future starts with a strong school system.



Don't Double My Rate

Congress left town last Friday without taking action to prevent the interest rates on new subsidized Stafford student loans from doubling.



Africa Trip

President Obama and the First Lady traveled to Senegal, South Africa, and Tanzania.



White House Mobile Apps

Visit the White House, anytime, anywhere, and on any device. Download it now.

TOP NEWS

July 2, 6:00pm
We're Listening to Businesses about the Health Care Law

July 1, 6:05pm
President Obama Visits Tanzania

July 1, 12:12pm
Commonsense Immigration Reform Will Strengthen Social Security

June 30, 3:15pm
President Obama Holds a Town Hall with Young African Leaders

June 29, 5:45am
Weekly Address: Confronting the Growing Threat of Climate Change

June 28, 5:13pm
Sweet Potatoes and Ending Hunger in Africa

June 27, 4:30pm
President Obama Visits Senegal

June 27, 1:02pm
Connecting Continents: Join a Google+ Hangout with First Lady Michelle Obama from South Africa

June 27, 11:30am
Traveling to Senegal, South Africa, and Tanzania

2014



DON'T HAVE HEALTH INSURANCE? OPEN ENROLLMENT FOR 2014 COVERAGE ENDS IN

DAYS 4	HOURS 22	MINUTES 5	SECONDS 5
------------------	--------------------	---------------------	---------------------

Make sure you're covered by March 31 at Healthcare.gov.

[GET COVERED NOW](#)

What are you looking for?

POPULAR TOPICS



Europe and Saudi Arabia Trip
President Obama travels to the Netherlands, Belgium, Italy, the Holy See, and Saudi Arabia from March 24-29, 2014.



Raise the Wage
No one who works full time should have to raise their family in poverty.



The First Lady's Trip to China
Follow the First Lady's trip focused on education from March 19-26, 2014.

ENGAGE

SOCIAL

NEWS

INITIATIVES

ENGAGE & CONNECT



Opening the Doors to the White House

President Obama is committed to making this the most open and participatory administration in history.

[Learn How You Can Participate](#)



White House Petitions

A new way to petition the Obama Administration to take action on a range of important issues.

[Visit We the People](#)

TOP NEWS

- March 26, 6:10pm
Day 3: President Obama Heads to Belgium, Speaks on U.S.-Europe Relations
- March 25, 5:53pm
Wrap Up: President Obama's Second Day in the Netherlands
- March 26, 8:32am
The First Lady's Travel Journal: Pandas!

@WHITEHOUSE

CT just voted to raise its minimum wage to \$10.10. RT if you agree it's time to #RaiseTheWage for all Americans.
<http://t.co/MygVXyg1Xw>

PHOTO OF THE DAY



[View More Galleries](#)



WATCH THE ADDRESS

President Obama's Address to the Nation

President Obama addressed the nation on the steps we are taking to keep the American people safe.

[LEARN MORE](#)



HOLIDAYS

Follow along during the 2015 Holiday season at the White House.



#COP21

Watch the President's speech on addressing climate change on a global scale.

GET PLUGGED IN



[THE PRESIDENT'S DAILY SCHEDULE](#)



[GET IN TOUCH WITH US](#)



[PHOTO OF THE DAY](#)



http://www.whitehouse.gov

BROWSE HISTORY

<http://www.whitehouse.gov>

Saved **9,493 times** between **December 27, 1996** and **March 26, 2014**.

PLEASE DONATE TODAY. Your generosity preserves knowledge for future generations. Thank you.

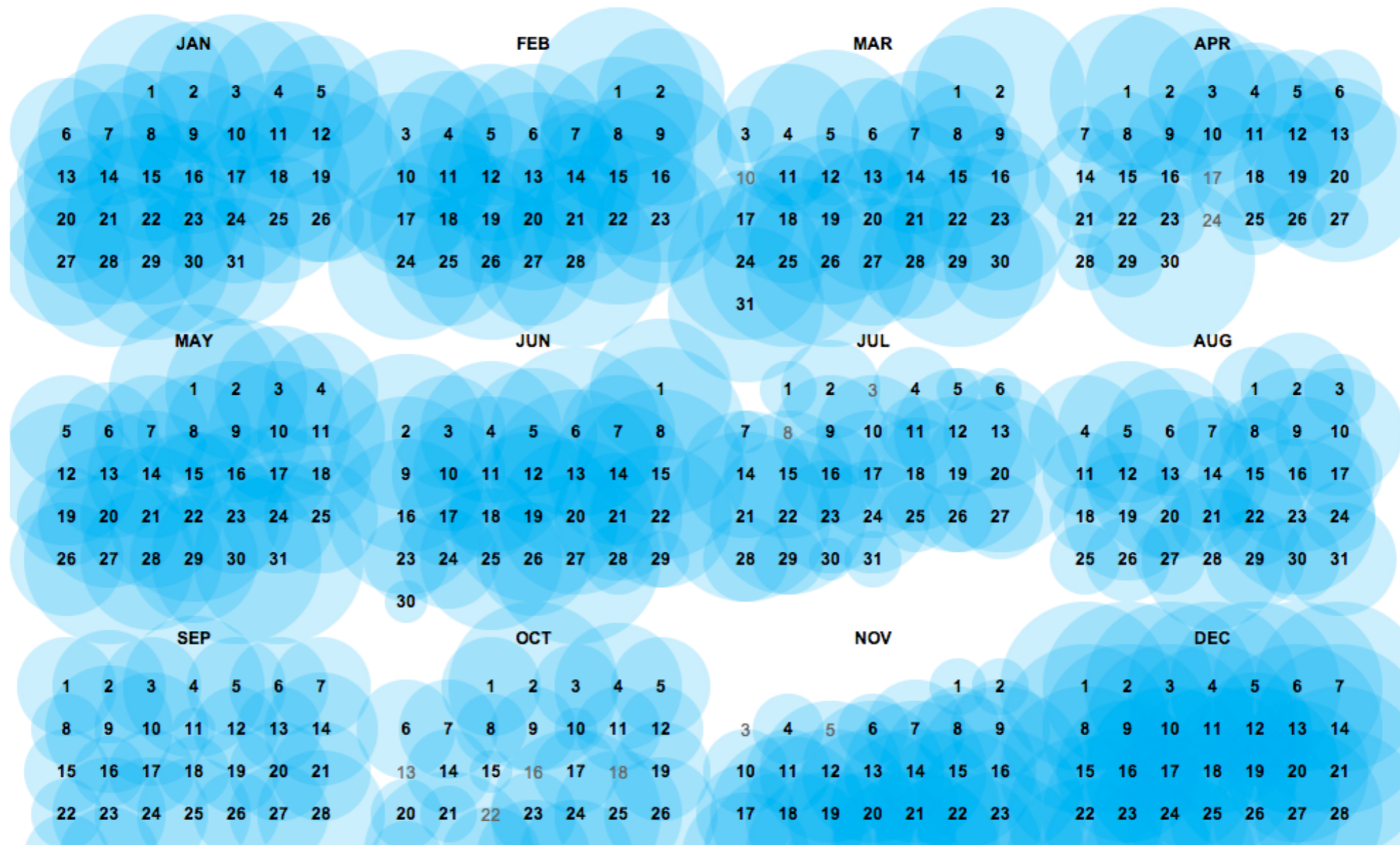
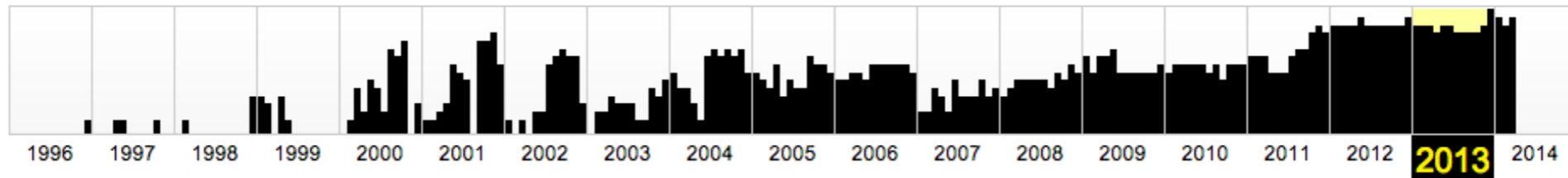

Web Standards Bodies - W3C



- The World Wide Web Consortium (W3C):
 - the main international standards organization for the World Wide Web
 - Founded by Tim Berners-Lee at MIT and currently headed by him,
 - Maintains hundreds of standards associated with the Web, e-commerce, and information representation
- Standards known as *Recommendations* which proceed through successive *Drafts*

- A recommendation progresses through five maturity levels:
 - Working Draft
 - Last Call Working Draft
 - Call for implementation
 - Call for Review of a Proposed Recommendation
 - W3C Recommendation (REC).

[Accessibility \(All\)](#)
[Accessible Rich Internet Applications \(WAI-ARIA\)](#)
[Audio](#)
[Authoring Tool Accessibility Guidelines \(ATAG\)](#)
[Best Practices for Authoring HTML](#)
[CC/PP](#)
[Content Transformation](#)
[CSS](#)
[CSS Mobile](#)
[DCCI](#)
[Declarative Web Applications](#)
[Device Description Repository](#)
[Device Independence Authoring](#)
[DOM](#)
[DOM events](#)
[Efficient XML Interchange](#)
[eGovernment](#)
[Electronic Commerce](#)
[Evaluation and Report Language \(EARL\)](#)
[Geospatial](#)
[Government Linked Data](#)
[GRDDL](#)
[Health Care and Life Sciences \(Semantic Web\)](#)
[HTML](#)
[HTML for User Agents](#)
[HTTP](#)
[InkML](#)
[Internationalization \(All\)](#)
[Internationalization of Web Architecture](#)
[Internationalization of Web Design and Applications](#)
[Internationalization of Web Services](#)
[Internationalization of XML](#)
[Javascript APIs](#)
[MathML](#)
[Media Access](#)
[Mobile Web Applications](#)

[Mobile Web Authoring](#)
[Mobile Web for Social Development](#)
[Multimodal Web Applications](#)
[OWL Web Ontology Language](#)
[P3P](#)
[PICS](#)
[Plugins](#)
[PNG](#)
[POWDER](#)
[Provenance](#)
[Quality Assurance \(QA\) Framework](#)
[RDF](#)
[RDF Best Practices](#)
[RDF Relationship to Other Formats](#)
[RDF vocabularies](#)
[RDFa](#)
[RIF Rule Interchange Format](#)
[Security for User Agents](#)
[Security for Web Applications](#)
[Semantic Annotation for WSDL and XML Schema](#)
[Service Modeling Language \(SML\)](#)
[SKOS](#)
[SMIL](#)
[SOAP](#)
[SPARQL](#)
[Stylesheets in XML](#)
[SVG](#)
[SVG Tiny](#)
[Timed Text](#)
[URI](#)
[User Agent Accessibility Guidelines \(UAAG\)](#)
[Voice](#)
[Web and TV](#)
[Web Architecture](#)
[Web Components](#)
[Web Content Accessibility Guidelines \(WCAG\)](#)
[Web Fonts](#)

[Web IDL](#)
[Web Real Time Communication](#)
[Web Services Addressing](#)
[Web Services Architecture](#)
[Web Services Choreography](#)
[Web Services Policy](#)
[Web Services Resource Access](#)
[WebCGM](#)
[WICD](#)
[Widgets](#)
[WSDL](#)
[XBL](#)
[XForms](#)
[XHTML 2](#)
[XHTML For Mobile](#)
[XHTML Modularization](#)
[XInclude](#)
[XKMS](#)
[XLink](#)
[XML](#)
[XML Base](#)
[XML Canonicalization](#)
[XML Design Techniques](#)
[XML Encryption](#)
[XML Events](#)
[XML Fragments](#)
[XML Pipeline \(XProc\)](#)
[XML Relationship to other formats](#)
[XML Schema](#)
[XML Signature](#)
[XML-binary Optimized Packaging](#)
[xml:id](#)
[XPath](#)
[XPointer](#)
[XQuery](#)
[XSL-FO](#)
[XSLT](#)

Web Standards Evolution

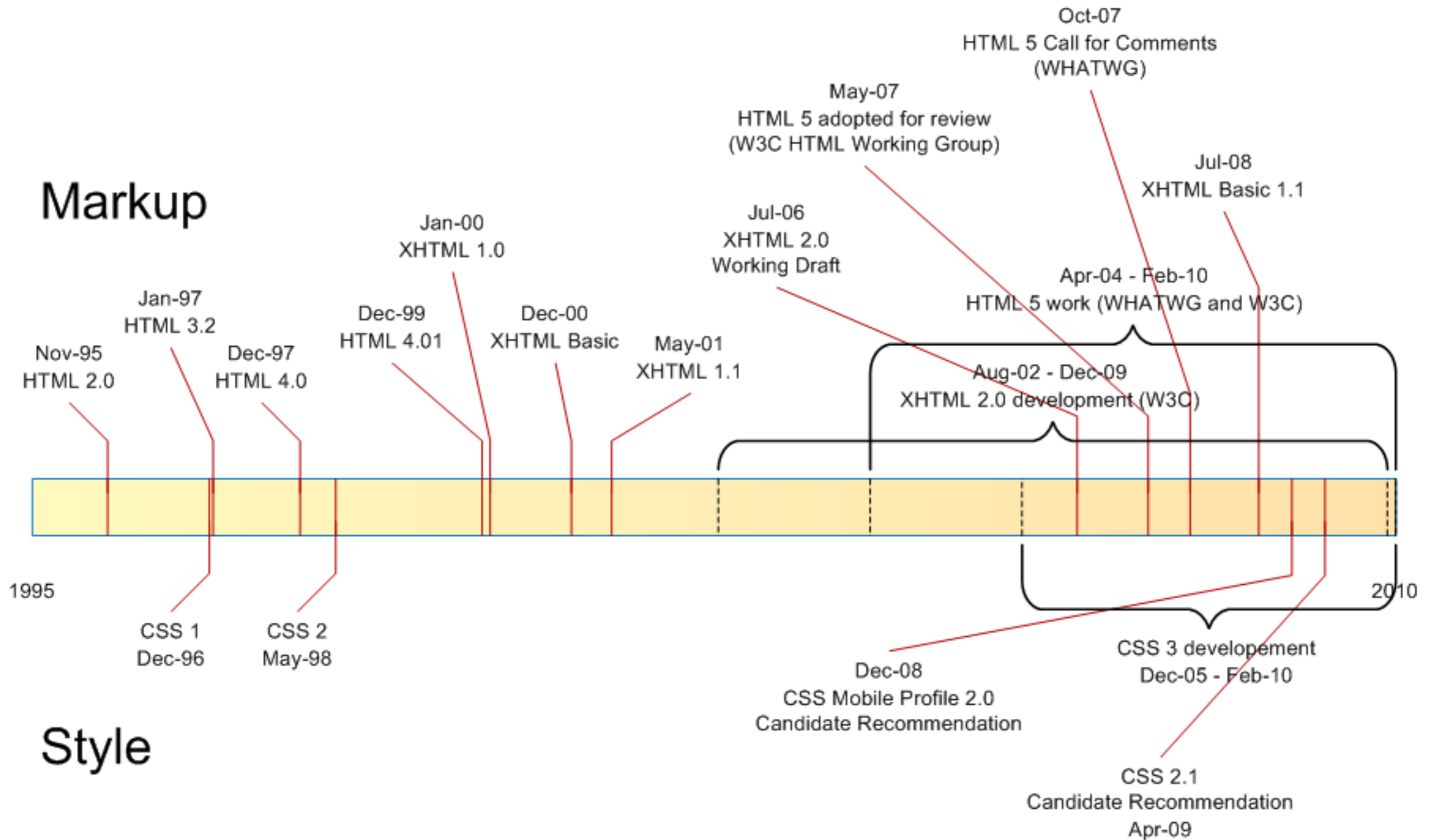

[Accessibility \(All\)](#)
[Accessible Rich Internet Applications \(WAI-ARIA\)](#)
[Audio](#)
[Authoring Tool Accessibility Guidelines \(ATAG\)](#)
[Best Practices for Authoring HTML](#)
[CC/PP](#)
[Content Transformation](#)
[CSS](#)
[CSS Mobile](#)
[DCCI](#)
[Declarative Web Applications](#)
[Device Description Repository](#)
[Device Independence Authoring](#)
[DOM](#)
[DOM events](#)
[Efficient XML Interchange](#)
[eGovernment](#)
[Electronic Commerce](#)
[Evaluation and Report Language \(EARL\)](#)
[Geospatial](#)
[Government Linked Data](#)
[GRDDL](#)
[Health Care and Life Sciences \(Semantic Web\)](#)
[HTML](#)
[HTML for User Agents](#)
[HTTP](#)
[InkML](#)
[Internationalization \(All\)](#)
[Internationalization of Web Architecture](#)
[Internationalization of Web Design and Applications](#)
[Internationalization of Web Services](#)
[Internationalization of XML](#)
[Javascript APIs](#)
[MathML](#)
[Media Access](#)
[Mobile Web Applications](#)

[Mobile Web Authoring](#)
[Mobile Web for Social Development](#)
[Multimodal Web Applications](#)
[OWL Web Ontology Language](#)
[P3P](#)
[PICS](#)
[Plugins](#)
[PNG](#)
[POWDER](#)
[Provenance](#)
[Quality Assurance \(QA\) Framework](#)
[RDF](#)
[RDF Best Practices](#)
[RDF Relationship to Other Formats](#)
[RDF vocabularies](#)
[RDFa](#)
[RIF Rule Interchange Format](#)
[Security for User Agents](#)
[Security for Web Applications](#)
[Semantic Annotation for WSDL and XML Schema](#)
[Service Modeling Language \(SML\)](#)
[SKOS](#)
[SMIL](#)
[SOAP](#)
[SPARQL](#)
[Stylesheets in XML](#)
[SVG](#)
[SVG Tiny](#)
[Timed Text](#)
[URI](#)
[User Agent Accessibility Guidelines \(UAAG\)](#)
[Voice](#)
[Web and TV](#)
[Web Architecture](#)
[Web Components](#)
[Web Content Accessibility Guidelines \(WCAG\)](#)
[Web Fonts](#)

[Web IDL](#)
[Web Real Time Communication](#)
[Web Services Addressing](#)
[Web Services Architecture](#)
[Web Services Choreography](#)
[Web Services Policy](#)
[Web Services Resource Access](#)
[WebCGM](#)
[WICD](#)
[Widgets](#)
[WSDL](#)
[XBL](#)
[XForms](#)
[XHTML 2](#)
[XHTML For Mobile](#)
[XHTML Modularization](#)
[XInclude](#)
[XKMS](#)
[XLink](#)
[XML](#)
[XML Base](#)
[XML Canonicalization](#)
[XML Design Techniques](#)
[XML Encryption](#)
[XML Events](#)
[XML Fragments](#)
[XML Pipeline \(XProc\)](#)
[XML Relationship to other formats](#)
[XML Schema](#)
[XML Signature](#)
[XML-binary Optimized Packaging](#)
[xml:id](#)
[XPath](#)
[XPointer](#)
[XQuery](#)
[XSL-FO](#)
[XSLT](#)



Web Standards Bodies -WHATWG

- The Web Hypertext Application Technology Working Group is a community of people interested in evolving HTML and related technologies.
- The WHATWG was founded by individuals from Apple, the Mozilla Foundation and Opera Software in 2004
- The WHATWG was formed in response to the slow development of web standards monitored by the World Wide Web Consortium (W3C), and its decision to abandon HTML in favor of XML-based technologies.
- The WHATWG has a small, invitation-only steering committee called "Members"



Welcome to the WHATWG community

Maintaining and evolving HTML since 2004

FAQ

Get answers to your questions about HTML and the WHATWG

HTML

Read, use, or implement the HTML Living Standard

Specs

See the other specifications developed at the WHATWG

Web Dev Edition

Read an edition of the HTML standard designed for Web Developers

Validator

Check your documents with an HTML validator

Help

Send questions and help others in the help@whatwg.org mailing list

Join

Comment on our Web standards and send proposals of your own

IRC

Chat with other members of the WHATWG community

Volunteer

See a list of tasks for which we need volunteers

W3C Web Standards Process

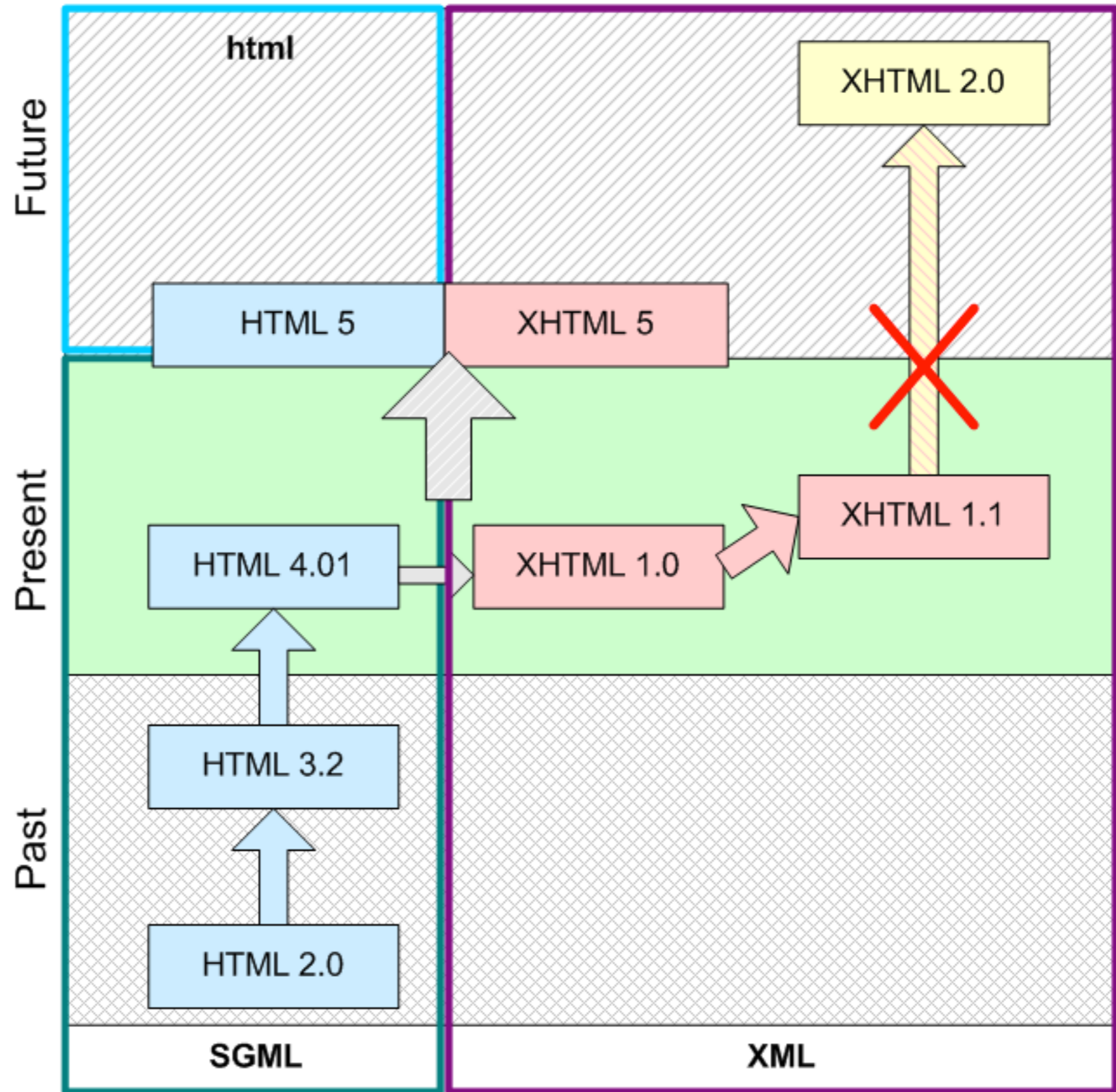



Vs



-
- The Mozilla Foundation and Opera Software presented a position paper at a W3C workshop in June 2004 focusing on developing technologies that are backwards compatible with existing browsers
 - The workshop concluded with a vote, 8 for, 14 against, for continuing work on HTML
 - W3C proceed with its XHTML 2.0 Effort
 - Work based upon that position paper moved to the WHATWG, and was soon renamed HTML5

<http://www.w3.org/> -- 7 March 2007 -- Recognizing the importance of an open forum for the development of the predominant Web content technology, W3C today invites browser vendors, application developers, and content designers to help design the next version of HTML by participating in the new [W3C HTML Working Group](#). Based on significant input from the design and developer communities within and outside the W3C Membership, W3C has [chartered](#) the group to conduct its work in public and to solicit broad participation from W3C Members and non-Members alike.

"HTML started simply, with structured markup, no licensing requirements, and the ability to link to anything. More than anything, this simplicity and openness has led to its tremendous and continued success," explained Tim Berners-Lee, W3C director and inventor of HTML. "It's time to revisit the standard and see what we can do to meet the current community needs, and to do so effectively with commitments from browser manufacturers in a visible and open way."

- In 2007, W3C abandoned its XHTML 2.0 effort, offered to merge its working group with WHATWG, and adopted the HTML5 specifications as the starting point for a W3C HTML5 effort

"It's time to revisit the standard and see what we can do to meet the current community needs, and to do so effectively with commitments from browser manufacturers in a visible and open way."

Tim Berners-Lee

Standardization Timetable

- 2008:W3C/WHATWG published the First Public Working Draft of the specification
 - *2011:‘Last Call’ an invitation to communities inside and outside W3C to confirm the technical soundness of the specification*
 - *2014: Target date for a ‘Recommendation’*
- However: in 2012, WHATWG and W3C have decided on a degree of separation.
 - *W3C will continue the HTML5 specification work, focusing on a single definitive standard. This is considered as a "snapshot" by WHATWG.*
 - *The WHATWG organization will continue its work with HTML5 as a "Living Standard". The concept of a living standard is that it is never complete and is always being updated and improved*

	2012	2013	2014	2015	2016
HTML 5.0	Candidate Rec	Call for Review	Recommendation		
HTML 5.1	1st Working Draft		Last Call	Candidate Rec	Recommendation
HTML 5.2 ^[32]				1st Working Draft	

Validator

Check your documents
with an HTML validator

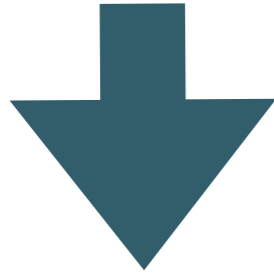

(X)HTML5 validation results for apps.html

Validator Input

File Upload  Choose File No file chosen

Show Image Report

Show Source

Validate

WHATWG Validator

About Validator.nu

Validator.nu is validation 2.0.

- [The Pitch](#)
- [No DTD-Based Validation](#)
- [Basic Usage](#)
- [Alternative Modes of Input](#)
- [Configurability](#)
- [Web Service API](#)
- [Preset Schemas](#)
- [Non-Schema Checkers](#)
- [FAQ](#)
- [Known Issues and Ideas for Future Development](#)
- [Reporting Bugs and Getting Help](#)
- [Feature Details for Custom Schemas](#)
- [Source Code](#)
- [Acknowledgments](#)
- [Links to Other Validators](#)
- [Terms of service](#)
- [Privacy policy](#)

The Pitch

- [\(X\)HTML5 validation](#).
- [RELAX NG validation](#)—XML syntax and Compact Syntax
- Schematron 1.5 validation (standalone schemas only—ISO Schematron or Schematron embedded in RELAX NG are *not* supported)
- NVDL-driven validation.
- XML 1.0 and [HTML5 parsing](#).
- [Bring your own schemas](#) or [use easy presets](#).
- [RESTful Web service API](#)

No DTD-Based Validation

- Validator.nu does not check for XML 1.0 validity constraints. That is, DTD validation is not performed.
- Validator.nu does not perform the duties of a “validating SGML parser” as defined in ISO 8879. In fact, this service does *not have any SGML functionality at all*. In particular, the HTML 4.01 support uses the HTML5 parser with some additional error conditions.

Basic Usage

Validator.nu has two facets: [generic](#) (complex UI) and [\(X\)HTML5](#) (simple UI).

Enter the URL (http, https or data IRI to be exact) of the document you want to validate in the field labeled “Document” and submit the form. That’s all it takes in most cases.

(X)HTML5 validation results for apps.html

Validator Input

File Upload No file chosen
 Show Image Report
 Show Source

Group Messages

1. **Error:** The character encoding was not declared. Proceeding using windows-1252.
2. **Error:** An `img` element must have an `alt` attribute, except under certain conditions. For details, consult [guidance on providing text alternatives for images](#).
From line 8, column 5; to line 8, column 34
`body>↵ ↵`
3. **Error:** An `img` element must have an `alt` attribute, except under certain conditions. For details, consult [guidance on providing text alternatives for images](#).
From line 13, column 6; to line 13, column 35
`</p>↵ ↵`
4. **Error:** No `p` element in scope but a `p` end tag seen.
From line 17, column 6; to line 17, column 9
`</p>↵ </p>↵`
5. **Error:** An `img` element must have an `alt` attribute, except under certain conditions. For details, consult [guidance on providing text alternatives for images](#).
From line 23, column 6; to line 23, column 35
`</p>↵
↵`

There were errors. (Tried in the text/html mode.)

Source

```
1. <!DOCTYPE HTML>↵
2. <html>↵
3. <head>↵
4. <title>Bundle APP Store</title>↵
5. <link type="text/css" rel="stylesheet" href="style.css" media="screen" />↵
6. </head>↵
7. <body>↵
8. ↵
9. <h3>Freebie</h3>↵
10. <p>↵
11. Stacksocial just published its so called Free Ondesoft Mac Tool Bundle, which contains 5 apps from
    Ondesoft. The bundle worth $146 will be probably available only a couple of days so youâ€™d better hurry up to
    get it.↵
12. </p>↵
13. ↵
14. <p>↵
15. ↵
16. </p>↵
17. </p>↵
18. <hr>↵
19. <h3>Macware Business Bundle</h3>↵
```

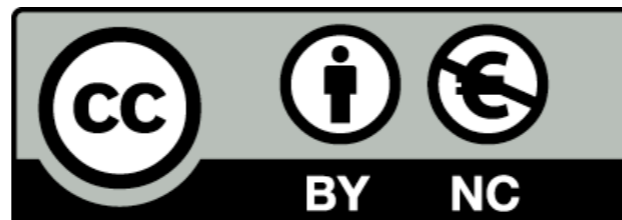

Except where otherwise noted, this content is licensed under a Creative Commons Attribution-NonCommercial 3.0 License.

For more information, please see <http://creativecommons.org/licenses/by-nc/3.0/>

